

# **AAADM**

American Association of Automatic Door Manufacturers

# **AUTOMATIC SWINGING DOOR**

## **OWNER'S MANUAL**

**Distributed by:**

A copy of the owner's manual has been provided with your order.  
For additional copies, please download and print from:  
[recorddoors.com>documents>owners manual](http://recorddoors.com>documents>owners manual)

<b>Section</b>	<b>Contents</b>	<b>Page</b>
Caution		2
To Our Customers		2
Service Availability		3
Compliance with Safety Standards		3
What You Should Know		3
Daily Safety Check		4
Operation		8
Limited Warranty		8

Part # 8-99-3014



# CAUTION

**An Improperly Adjusted Door** can cause injury and/or equipment damage.

Inspect door operation daily using safety checklist in Owner's Manual and at door.

Have door adjusted as described in Owner's Manual.

Safety devices should be in place and operational.

Have door inspected at least annually by an *AAADM* certified inspector.

In the following manual, the word:

**Caution** means that injury or property damage can result from failure to follow instructions.

**Note** is used to indicate important steps to be followed or important differences in equipment.

## To Our Customers

The purpose of this manual is to familiarize you with your automatic door system. It is essential that you "know your system" and that you recognize the importance of maintaining your door system in compliance with the industry standards for safety.

**It is your responsibility**, as owner or caretaker of the equipment, to inspect the operation of your door system on a daily basis to ensure that it is safe for use by your invitees, customers, or employees.

This manual will provide you with a description of the operation and maintenance requirements of your door. It also provides the instructions for the *Daily Safety Check*.

Should the door fail to operate as prescribed in the *Daily Safety Check*, or at any other time for any other reason, **do not attempt to repair or adjust the door**. Call an AAADM Certified service technician. These technicians are trained to service your door in accordance with applicable industry safety standards.

## Service Availability

Automatic door products are distributed through a nationwide network of authorized automatic door suppliers for sales, installation, and service.

Should you need service on your door system, consult the respective door manufacturer or its authorized representative.

## Compliance with Safety Standards

Your door system was designed to the latest operating and safety standards. In order to ensure the continued safe operation of your door, it is important that:

- Your door system be maintained in compliance with the standards of the industry.
- Proper signage and labels be applied and maintained on your doors. If signage is removed or cannot be read, request replacements when calling for service.
- Automatic doors should be checked by an AAADM certified inspector at least annually.

**AAADM**, the American Association of Automatic Door Manufacturers, has established a program to certify automatic door inspectors. Through this program, the inspectors are trained to check your door systems for compliance with the American National Standards Institute standard ANSI/BHMA A156.10.

## What You Should Know

Be sure that an automatic door supplier has provided the following for each door:

1. Instruction on how to conduct the *Daily Safety Check* \*(by walk-through example).
2. Location of function switches and instruction in their use.
3. Circuit breaker or main power disconnect location for each door system.
4. Number to call for service or questions about your system if you are uncertain of any condition or situation.
5. AAADM inspection form or a work order signed by an AAADM certified inspector.
6. A completed Annual Compliance Inspection label, located at the bottom of the Safety Information label affixed to the door.
7. Warranty information for each door.

**Note:** If there are any problems, or if you are unsure about the safe performance of the door, **discontinue door operation immediately** and secure the door in a safe manner. Call your authorized automatic door professional for repairs.

**\*Note:** AAADM Daily Safety Check videos are available. Contact an automatic door supplier or AAADM.

Automatic swinging doors are installed in a variety of combinations.

- Doors Swing In - Swing Out in Emergencies
- Doors Swing Out
- Single, Pairs, or Double Egress
- One-Way Traffic or Two-Way Traffic
- Activated by Floor Mat, Sensors, or Push Switches

They always require the following safety items:

- A Safety Zone to cover the area the door travels.
- Guide Rails on the swing side of the door (unless a wall is in the same position).

## Daily Safety Check (All figures and diagrams are for purposes of illustration only)

Perform the following safety checks *daily* on each automatic swinging door to ensure your customers' safety and your own protection. Perform these tests while traffic is restricted from all detection and sensing zones.

### Sensor Activation / Presence Detection Safety

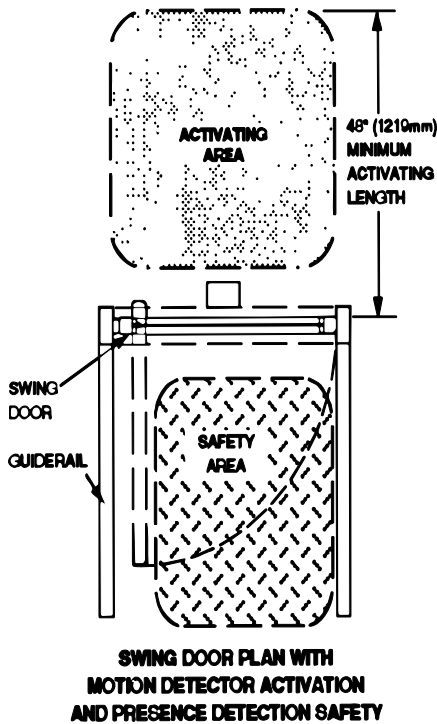

Figure 1

1. Check electronic sensor by walking toward the door opening at a moderate speed. The door should start opening when you are about four feet from the door, should open smoothly and stop at fully open without impact. Move slowly through the door opening (6 inches per second), stop in the swing path and pause for 10 seconds. The door should remain open. If two way traffic, repeat from the other side of the door.
2. Step out of the sensor zone. After a brief time delay (at least 1 1/2 seconds) the door should close smoothly and without impact.
3. For one way traffic doors, approach the safety side of the door, then have someone else approach the activating side of the door.

- If the door is equipped with an overhead mounted presence sensor, as long as you are in the safety area of the door it should not open. (See Figure 1)
- If the door is equipped with a door mounted presence sensor, the door may start to open but should reverse, stop, or slow down. (See Figure 2).

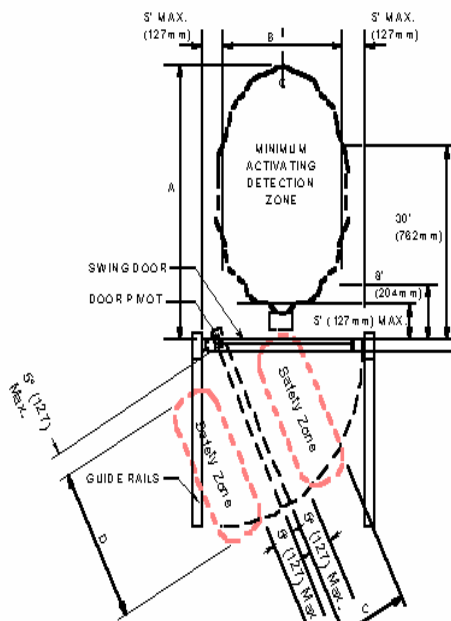

Figure 2

4. Crouch motionless in the door opening for at least 4 seconds.
  - If the door is equipped with an overhead mounted presence sensor, the door should not close.
  - If the door is equipped with a door mounted presence sensor, the door should stop, or slow down.

**Caution: If safety sensor is not working, door may swing toward you without stopping.**

## Floor Mat Activation/Floor Mat Safety

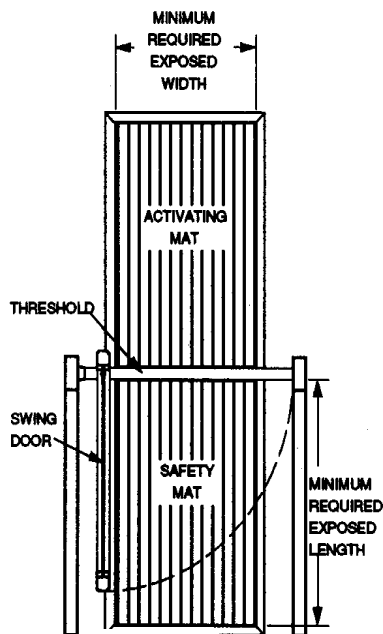

Figure 3

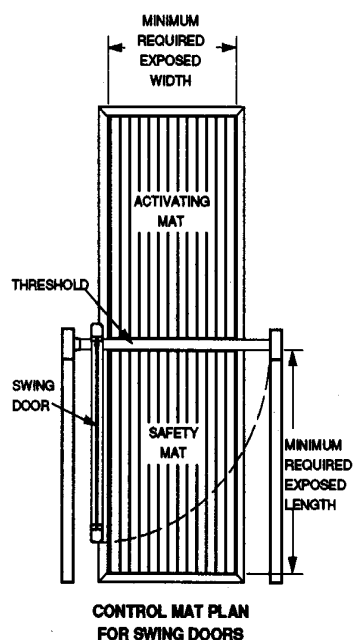

Figure 4

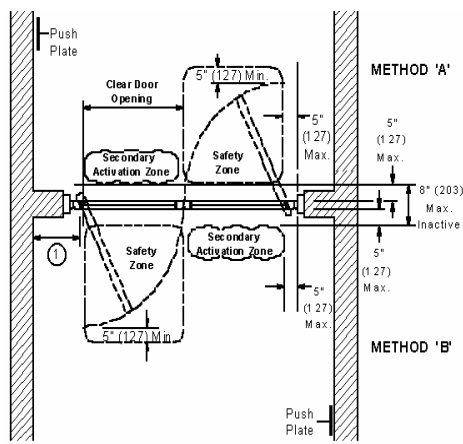

Figure 5

1. Step on the "opening" (activating) mat.
2. It is necessary to have a safety mat covering the entire area the door swings over. Step through the doorway onto the safety mat and remain motionless for 4 seconds. The door should remain open. Repeat at several locations on the mat. (See Figure 3 or 4)
3. Step off the safety mat. After a brief time delay (at least 1 1/2 seconds) the door should close smoothly and without impact.
4. With the door closed, step on the safety mat on the swing side. Have someone step on the activating mat. Door should remain closed as long as someone remains on the safety mat.

**Caution: If safety mat is not working, door may swing toward you without stopping.**

5. Check the mat molding and threshold. It should be complete and secured with all required screws.

## Double Egress-Using Knowing Act

1. Double Egress doors are commonly activated by a knowing act switch. Momentarily operate knowing act switch. Doors should open smoothly and stop at fully open without impact. Doors should remain fully open for a minimum of 5 seconds before closing.
2. As the door closes, approach the door from the non-swing side, and the door should reopen. Continue across the threshold and stand motionless for 10 seconds. Door should not contact you.
3. Continue through the door and the door should start closing after a minimum of five seconds. Door should close smoothly and without impact.
4. Approach the safety side of the door. Have someone else activate the knowing act switch. If the door is equipped with an overhead mounted presence sensor, as long as you are in the safety area of the door, it should not open. (See Figure 5)
5. If the door is equipped with a door mounted presence sensor, the door may start to open but should reverse, stop, or slow down. (See Figure 6)
6. Repeat for the other door panel.

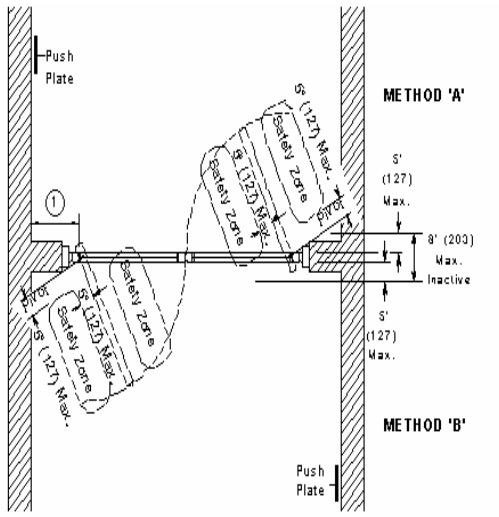

Figure 6



Figure 7

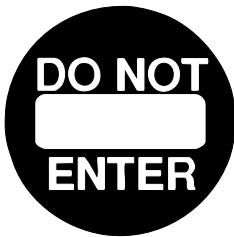

Figure 8



Figure 9

## General Safety

Pay attention to the following general safety items and conduct checks periodically where noted.

1. **Force** Force to prevent the door from closing should not exceed 30 pounds. This can be measured with a force gauge.
2. **Breakout Stop.** Center pivoted in-swinging doors may be supplied with an emergency breakout stop or switch that will allow the door to open in the direction of emergency egress. Call your supplier for details.

When the door is pushed into the breakout mode, check that door will not activate.

3. **Signage.** The door should have decals properly displayed as follows at a height 58 inches,  $\pm 5$  inches from the floor to the centerline of the sign (unless otherwise noted). The decal shall be a minimum of 6 inches in diameter (unless otherwise noted):
  - A. If one way traffic, an arrow (See Figure 7) shall be visible from the approach side of a swinging door, mounted on the door. The decal shall have a green circle surrounding a black arrow on a white background. The words "Automatic Door" with letters  $\frac{1}{2}$  inch high shall be visible from the approach side.
  - B. If one-way traffic, an international "DO NOT ENTER" decal (See Figure 8) shall be visible from the side that would swing toward pedestrians attempting to travel in the wrong direction. The decal shall have a red circle with the wording, "Do Not Enter", in white letters in the red circle. The words "Automatic Door" with letters  $\frac{1}{2}$  inch high shall be visible from the side that would swing toward pedestrians attempting to travel in the wrong direction.
  - C. Swinging doors serving two-way traffic shall be marked with a decal, visible from both sides of the door, with the words "Automatic CAUTION Door". (See Figure 9) The letters in the words "Automatic Door" must be at least  $\frac{1}{2}$  inch high. The sign shall be made with black lettering on yellow background.
  - D. One way traffic doors shall be marked on the non swing side with a decal with the words "Automatic Door". The letters in "Automatic Door" must be at least  $\frac{1}{2}$  inch high.
  - E. Double egress doors shall be marked with a decal, visible from the swing side of the door, with the words "Automatic CAUTION Door". On the non-swing side, the words "Automatic Door" with letters  $\frac{1}{2}$  inch high shall be visible.

**AUTOMATIC DOOR  
ACTIVATE SWITCH  
TO OPERATE**

Figure 10

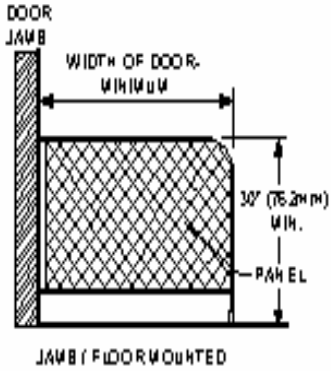

Figure 11

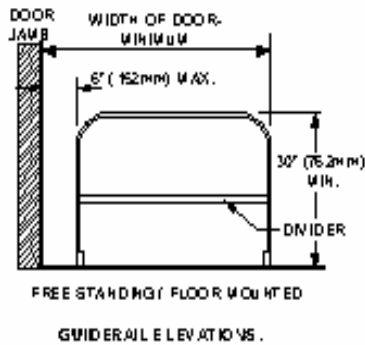

Figure 12

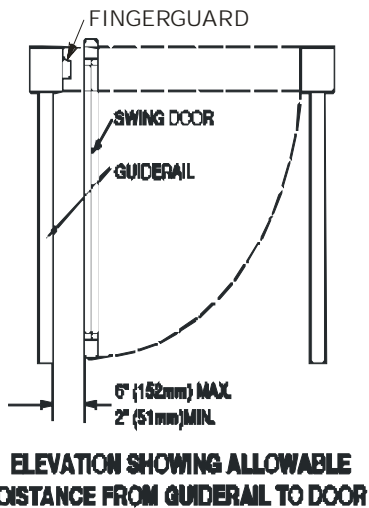

Figure 13

F. An AAADM safety information label should be affixed on the door or frame in a protected, visible location. If you need additional decals or labels for automatic doors, call your automatic door supplier.

4. **Activating Switch.** (Knowing Act) Doors equipped with a manual activating switch shall hold fully open for a minimum of 5 seconds before closing.

Doors equipped with a manual activating switch shall have a decal as follows: "Automatic Door. Activate Switch to Operate." The decal should be visible from both sides of the door or the side with the knowing act switch if there is only one. (See Figure 10).

5. **Guide Rails.** Check that guide rails or other barriers or separators are present (two per swing door side) and firmly anchored. Rail length should be the width of the open door or greater. (See Figures 11, 12, 13).

6. **Lock Stile.** With door open, grasp lock stile of door and attempt to move vertically and horizontally. There should be no looseness in the door pivots or in connections between door and operator.

7. **Housekeeping.** Check the door area for tripping or slipping hazards.

Check all door panels for damage. Make sure that all hardware and overhead covers are properly secured. There should be no bulletin boards, literature racks, merchandise displays, or other attractions in the door area that would interfere with use of the door or invite people to stop or stand in the door area.

8. **Traffic Patterns.** Observe traffic patterns. Plan routing so people enter and exit in a straight approach, directly toward the center of the door opening.

9. **Finger Guard.** If installed, inspect finger guard to see that it is secure and in good repair. (See Figure 13)

**IF YOU HAVE A PROBLEM, TURN OFF THE DOOR OPERATING EQUIPMENT AND CALL AN AUTOMATIC DOOR SUPPLIER TO MAKE PROMPT REPAIRS.**

## Operation

The typical installation includes a small control panel on one endcap of the header assembly. The panel is composed of – (a) Three position rocker switch providing ON / OFF / OPEN functions; (b) Red LED indicator; (c) Black reset button.

In standard operation, the red LED is not illuminated. If a problem occurs, inhibiting door operation, the LED will flash slowly (once per second). To resolve, press and hold the black button until the flashing stops (6 – 8 seconds). This will reset the unit, clear the alarm, and turn off the LED. Please note, if the condition that caused the alarm has not been corrected, the alarm will occur again.

Alternatively, a three position toggle switch providing ON / OFF / HOLD OPEN functions may be mounted on the door jamb, adjacent framing, or at a remote location.

## Warranty

We warrant to the buyer that record-usa door systems have been manufactured from high-grade materials with first-class workmanship. Subject to the other conditions of this Warranty, if any parts of our own manufacture prove defective under normal use and service within two years of purchase (6100 swing series within one year of purchase), we shall repair or replace such parts free of cost. If any equipment or parts not of our own manufacture are utilized in connection with this door operator and equipment, we shall assume responsibility and liability for defects only to the extent of such adjustment as the manufacturer thereof makes to us. It is the responsibility of the buyer to furnish all labor and expense necessary to replace the part. The warranty shall not extend beyond two years from the date of purchase regardless of any replacements, which may be made.

Our obligations under this Warranty are conditional upon the buyers having

- (1) given us prompt written notice of alleged defects, and
- (2) upon our request, returned the allegedly defective item(s) within 30 days to our works in Monroe, North Carolina, freight prepaid, for our inspection.

We shall have no obligation or liability, under this Warranty or otherwise, in the event of

- 1) improper installation or application of product;
- 2) misuse, neglect or accident; and
- 3) installation, service, repair or alteration in any way by any person not expressly authorized in writing for such purpose. However, in no case shall we have any obligation or liability beyond two years after original installation or any replacement or repairs that may be made.

We reserve the right, without obligation, to inspect all installations of record door operators and equipment for the protection of both the end user and ourselves.

In no event shall we have any obligations or liability, under this Warranty or otherwise, resulting in whole or in part for damage to defects in the door operator or equipment caused by abuse, misuse, malicious mischief, acts of God, casualty, improper handling or the negligence of the owners or others. Nor shall we have any obligations or liability for any loss, cost or expense incurred in the repair or replacement of the door operator or equipment except on express written authority from our office in Monroe, North Carolina.

The buyers sole remedy against us for any alleged defects in the record door operator or equipment shall be as provided in this Warranty. We hereby disclaim all other obligations and liability for damages, including any incidental consequential damages.

**THIS WARRANTY IS IN LIEU OF ALL OTHER WARRANTIES, EXPRESSED OR IMPLIED, INCLUDING ANY IMPLIED WARRANTY OF MERCHANTABILITY OR FITNESS FOR A PARTICULAR PURPOSE.**

This Warranty may not be changed, expanded or modified in any way except in writing, signed by our duly authorized representative.







# Power assist swing door operator display panel

An optional feature for the DFA127 swing door operators is an electronic control panel to select the operating mode of the door and provide feedback on the door status.

Included are six pushbutton / keys

**AUTO**

Auto is the standard operation mode and the operator will work in the power assist mode.

**OFF**

Off will turn off the power assist function. You still can open the door manually, however you have to push with more force.

**OPEN**

OPEN automatically opens the door and remains open.

**EXIT**

Reserved for other type of doors, do not use.

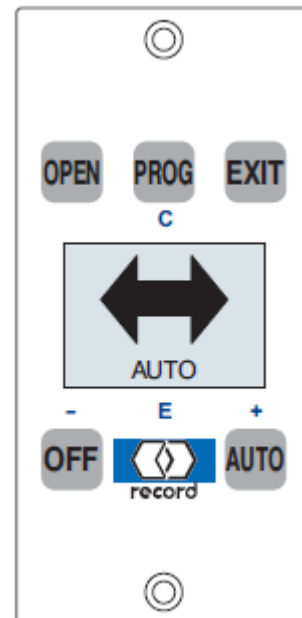

The control panel can be "locked", preventing unauthorized use, by pressing the key sequence.



A small square with an "X" will appear on the left of the display.

To re-enable the keypad, repeat the above sequence.

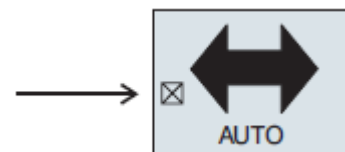

The control panel includes a backlit display providing confirmation of the above mode selection and will additionally indicate when the system has an abnormal operating status. Abnormal status indication is in the form of a short text description of the anomaly. Examples include "Obstruction", "Encoder Fault", etc. The user may be able to re-solve some issues without requiring a service call. Certain door status will require an authorized technician to service the door.

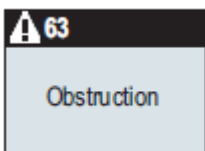

Example: Obstruction indicates the door has encountered significant resistance in either opening or closing and cannot move without exceeding code limited forces. Inspect the bottom guides, weatherstripping, etc., around the perimeter of the door and in the door's path.

When another error code shows up it may help to reset the door operator.

Press the  button for 8 seconds. The screen at right will appear.

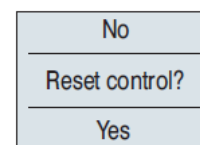

Press the  button again to initiate a software reset; normal operation should resume in a few seconds. If not, contact your record dealer.